

S-energy®

Lubricated Rotary Screw Air Compressors

Constant Speed and Variable Speed Drives

18-75 kW ■ 25-100 Horsepower



- Reliable
- Quiet
- Energy Efficient
- Small Footprint
- Easy to Maintain



SULLAIR®
Always air. Always there.

Sullair Capabilities

Sullair Leadership

Since 1965, Sullair has been recognized around the world as an innovator and a leader in rotary screw compression and vacuum technology. For more than 40 years, Sullair has designed and manufactured its own rotors and air end assemblies at the corporate headquarters in Michigan City, Indiana.

The award-winning rotary screw design sets the industry standards and delivers the quality and reliability one expects from a leader.

Sullair Technology

Utilizing the most modern technologies, equipment and advanced manufacturing techniques, Sullair designs, manufactures, assembles, and tests the most innovative compressed air and vacuum products in the industry. Sullair products are known around the world for their universally applicable design, outstanding craftsmanship and superior quality.

Sullair's Statistical Process Control

Sullair's Statistical Process Control (SPC) system monitors rotor quality standards to assure consistent compressor and vacuum performance.

Sullair's Commitment to Innovation

Underlying Sullair's leadership is a dedication to excellence and a commitment to innovation. Sullair is constantly exploring new ideas and seeking new ways to meet industry's need for increasingly energy-efficient compressed air and vacuum solutions.

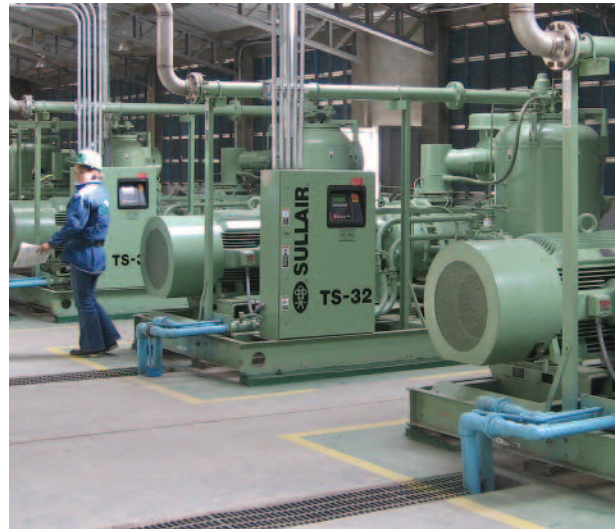
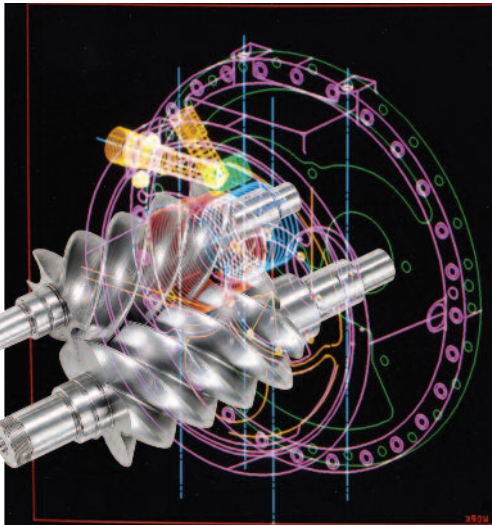

Sullair Air System Solutions

Sullair offers air system solutions—*a total compressed air system*—to help compressed air users reduce energy costs and improve productivity

by analyzing, managing and controlling total compressed air systems. Sullair's air system solutions include: plant air system audits,

energy efficient products, compressed air system controls, monitoring and management systems, air distribution products, and after-purchase support.

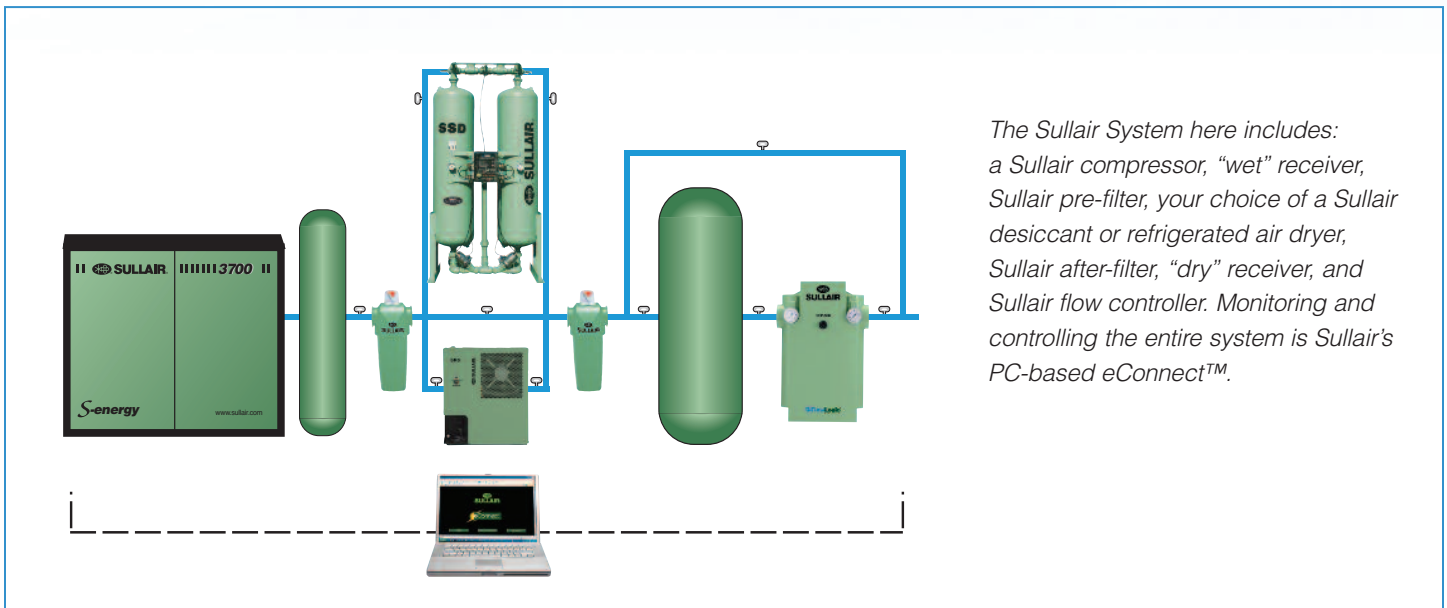

The Sullair System here includes: a Sullair compressor, "wet" receiver, Sullair pre-filter, your choice of a Sullair desiccant or refrigerated air dryer, Sullair after-filter, "dry" receiver, and Sullair flow controller. Monitoring and controlling the entire system is Sullair's PC-based eConnect™.

Sullair Reduces Your Life-Cycle Costs

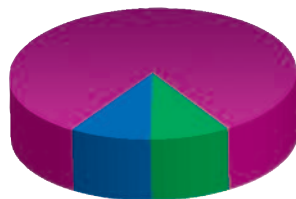

- Equipment
- Maintenance
- Electricity

Air Compressor Life Cycle Costs

According to *Best Practices for Compressed Air Systems*, Compressed Air Challenge, Second Edition, 2007, energy costs now

represent 82% of the total operating expenses. Energy savings from Sullair **S-energy** compressors can significantly reduce life cycle costs.

The Sullair **S-energy** compressors significantly reduce operating and energy costs over the entire compressor life cycle. Contributing to the energy savings are:

- Sullair's proven air-end with the low restriction inlet valve
- High efficiency fan
- Low pressure drop air-fluid separation system to prevent energy loss

Sullair designs deliver cost savings for the life of the product. Improved air filtration translates into:

- Extended separator life
- Improved fluid filter life
- Less lubricant contamination

To reduce fluid disposal costs, we offer our biodegradable Sullube™ 8000-hour fluid, or 24KT™, a long-life fluid that never needs changing.

Features and Benefits That Set Sullair Apart

These Sullair compressors provide more performance and efficiency than any other compressors in this horsepower range and set new standards in virtually every category.

Standard Features

- Low restriction inlet valve for better CFM performance
- Low life cycle costs including long-life bearings, rotors, and consumable parts
- Less than 1 ppm fluid carryover
- Excellent motor cooling design characteristics for longer motor life
- Sequencing standard
- NEMA 4 standard
- WS microprocessor standard
- Smallest footprint in its class
- Quietest in its class, as low as 67 dBA
- 12 unique serviceability features
- Environmental, health, and safety design features
- Sullube™—8000-hour, non-varnishing, biodegradable compressor fluid
- Optimalair™ air filter provides 10 times better filtration than other filters

Quiet Design

This Sullair **S-energy** Series incorporates many design features to reduce the noise of the machine:

- Air-end, motor, and receiver tank are mounted on rubber isolators
- Insulated intake and exhaust louvers
- Low-noise fan

In fact, these compressors are so quiet they can be installed anywhere in your facility.

The Smallest Footprint in Its Class

These Sullair **S-energy** Series compressors meet the need for a smaller footprint.

- More compact than any similar compressor on the market

- All the maintenance is performed from one side, reducing the amount of clearance and floor space typically required

Options

- Choice of air- or water-cooled*
- 24KT™ 10-year air-end warranty
- Cold weather package
- Weather hood
- Total package filtration
- Other motors and starters
- Heat recovery

*Water-cooled available on 40-100 hp



For the Maximum Energy Efficiency and Operating Consistency, Sullair Air Compressors with **VSD**

The Sullair Compressors with **VSD** provide:

- Excellent energy savings
- Relief from potential peak demand charges
- Possible utility company rebate
- Alleviation from electrical harmonics
- Stable system pressure
- Consistent product quality
- Reduced system air leaks
- Reduced storage requirements
- Flexibility for future growth
- Lowest 5-year life cycle cost
- Available on models 25 Hp to 100 Hp

Your Compressed Air System can Improve Your Bottom Line: 35% Energy Savings in the First 5 Years

In just 5 years, the electrical power cost to operate a standard compressor can be more than 6 times greater than its purchase price.

Standard Compressors

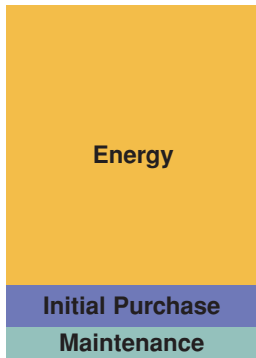

Sullair's VSD Compressors

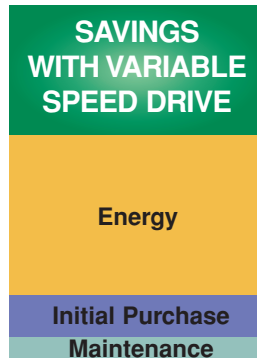

Total Compressor Flexibility

Sullair's **VSD** compressors provides the flexibility to vary both capacity and pressure. This flexibility makes it possible to "grow" your air system without adding more compressors.



↑ FOR TODAY, ↑ TOMORROW, ↑ AND THE FUTURE

Variable Speed Drive is the superior alternative to other compressor control systems.

The chart below is a representation of nominal control systems for generic comparative purposes. A detailed and accurate comparison of specific compressor models is available from your Sullair representative or authorized distributor.

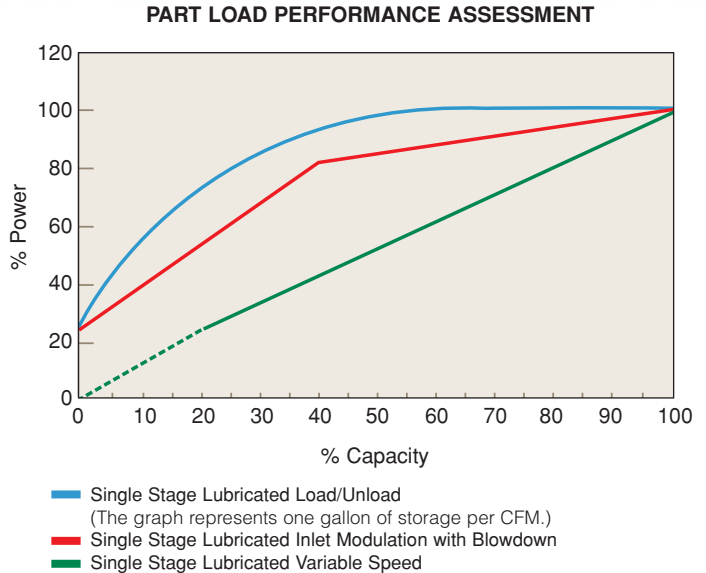

Reference: Compressed Air and Gas Handbook, 6th Edition, pages 221-223.

Stable System Pressure Improves the Consistency of Your Process to Reduce Product Rejects

- Lowers air system leaks
- Reduces system storage requirements
- Provides increased energy savings to increase profits

Standard Compressors

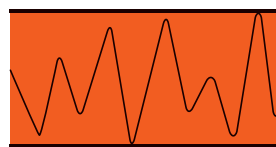

Sullair's **VSD** Compressors

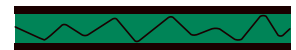

Soft Start is Standard with Unlimited Starts and Stops

- No need for Wye Delta and other soft starters
- No need to control the number of hot or cold starts
- Unlimited starts and stops save electrical costs
- Avoids high electrical current at start-up

VSD Avoids Potential Peak Demand Charges

VSD compressors provide the highest power factor over the entire frequency range, often avoiding utility company penalties.

Senergy® Series Compressor

Before we designed these compressors, we reviewed every aspect of product development with the customer and the maintenance staff in mind. The result is Sullair reliability in the most compact, most robust, most maintenance-friendly and quietest compressor package available on the market.

Multiple features of the **Senergy** Series revolutionize the compressor's serviceability and provide for a cleaner, safer work environment and cost-effective compressor. Standard maintenance can all be performed from this side.

WS Microprocessor Control System



With the simplified WS microprocessor, there are no complicated menus to manage.

- The graphic display is clear and concise
- Get the critical operations information more easily, including status, temperature, pressure, and load/unload set points
- Use a Windows PC to remotely monitor, upgrade the software, and set up changes
- Built-in sequencing of up to 16 machines

Sullair Motor Features:

- Slow speed—1800 rpm
- Cast iron construction
- NEMA design
- Direct coupled/flange mounted
- Most comprehensive warranty in the industry

Drive Coupling Element

Easy access through a large opening and a wrap-flex element allows change without disturbing the hubs.

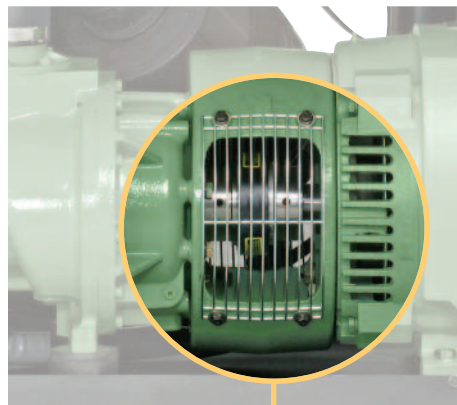

Quick Thermostat Change

To change the thermostat, simply thread the old thermostat out, and the new one in.

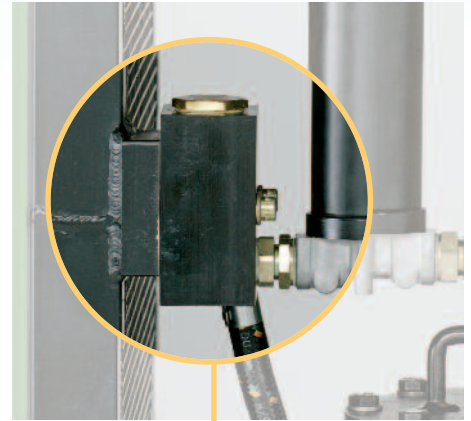

Environmental Protection Pan

This series features a fully sealed environmental protection pan to capture spills that may occur during servicing.

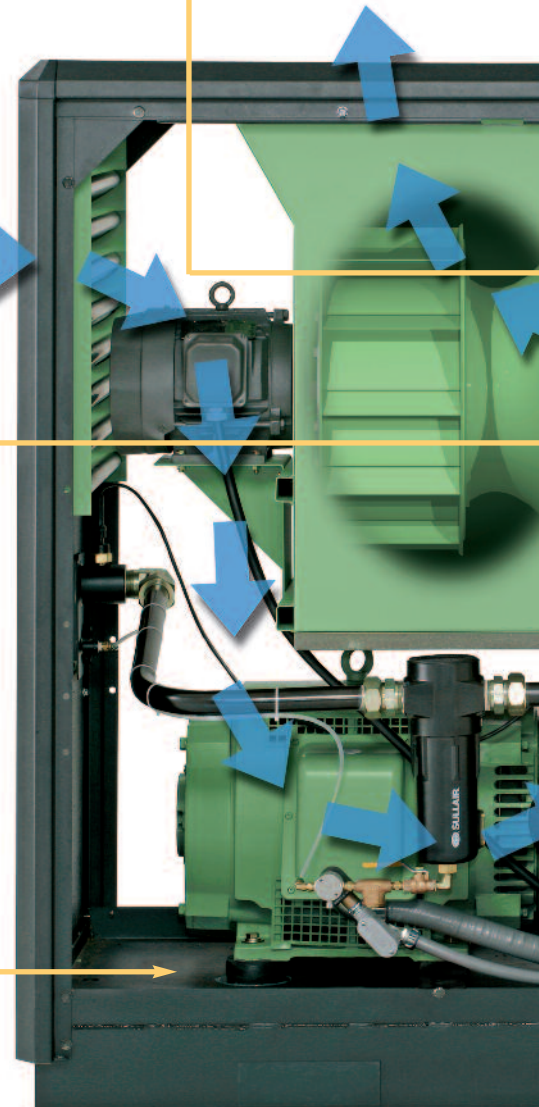
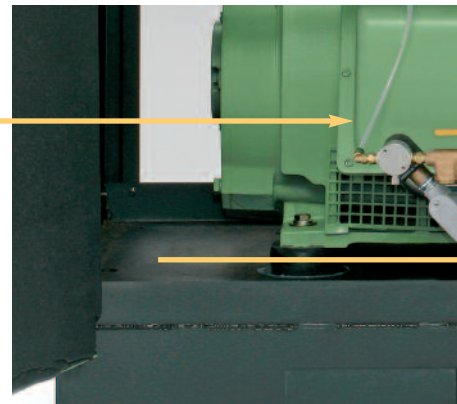

ors Are Easiest to Maintain

Improved Separator Maintenance

Simply unbolt the lid and lift it off using the handle. No tubing to disconnect, prevents leaking and saves service time.

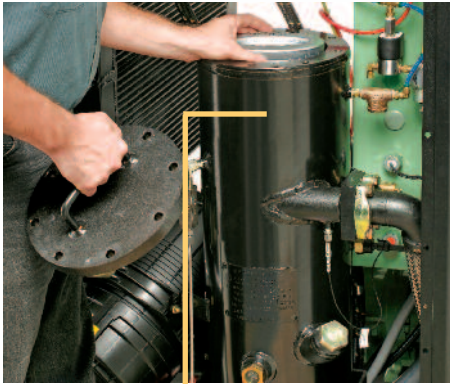

Quick Access to Cooler

With the removal of just a few bolts, the cooler slides out on rails for easy routine cleaning.



Sullair Optimizer™ Air/Fluid Separator

- High efficiency molded media
- Lower pressure drop reduces power consumption
- Less than 1 ppm carryover reduces cost of makeup fluid



Fiberglass Fluid Filter

- Coreless, non-metallic design means easy disposal
- 20% more efficient than common cellulose media
- Better filtration lengthens the life of the compressor unit

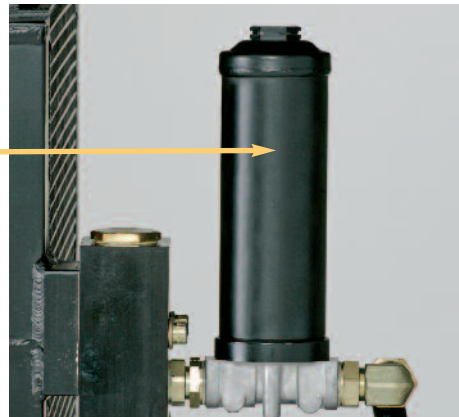

Simplified Filter Change

The fluid filter is in an inverted position to minimize lubricant loss during filter changes.



Sullair Optimalair™ Air Filter

- Provides the finest inlet filtration in the industry (.4 micron)
- Keeps fluid clean and extends life of internal components
- Reduces pressure drop during operating life, resulting in energy savings

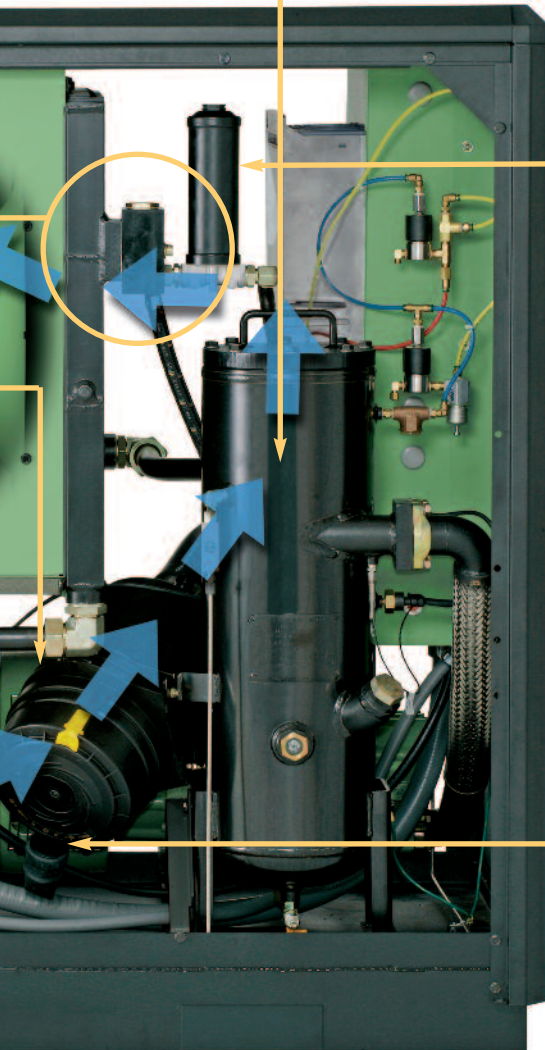

Sullair's Variable Capacity Control Technology

How the Spiral Valve Operation Works

The compression volume varies to suit the air demand by progressively opening or closing internal bypass ports on the air-end.

Capacity is matched to system demand, reducing cycling time and extending component life.

Part load capacity and efficiency can produce energy savings up to 17%.

Variable Displacement Air-End

Sullair's variable displacement air-end maintains system pressure to

the plant to match air demand. Since the VCC compressors use large, efficient, slow running rotors, a lower power consumption is achieved at the top end of capacity. Oil foaming does not occur, air is not wasted to atmosphere, and bearings last longer.

The motor and air-end run at optimum speed and therefore maintain optimum efficiency throughout the full variable output range.

Sullair VCC compressors react quickly to rapid changes in demand. The effective rotor length is progressively reduced as the demand is reduced which provides the most efficient part

load control system to 50% output. This system is extremely simple and provides a cost-effective, energy-efficient control alternative.

Bypass Ports in Stator

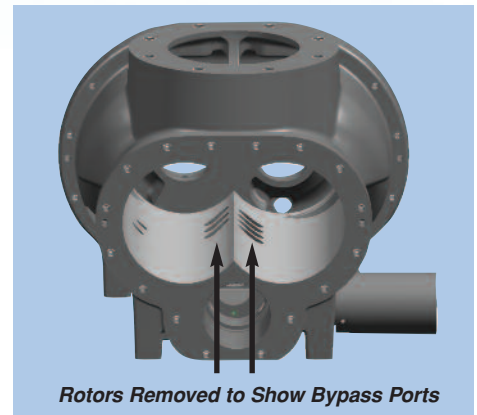

Closed Bypass Ports

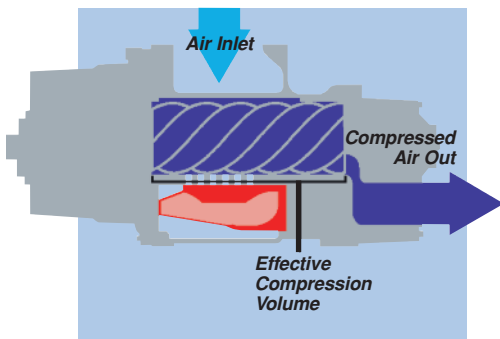

Partially Open Bypass Ports

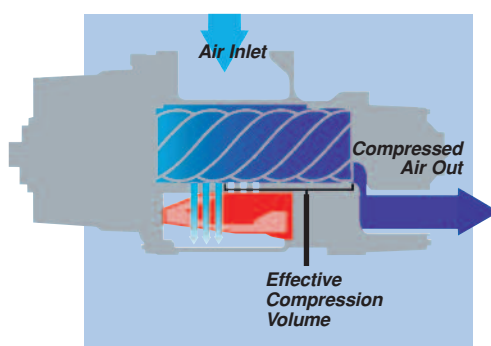

Open Bypass Ports

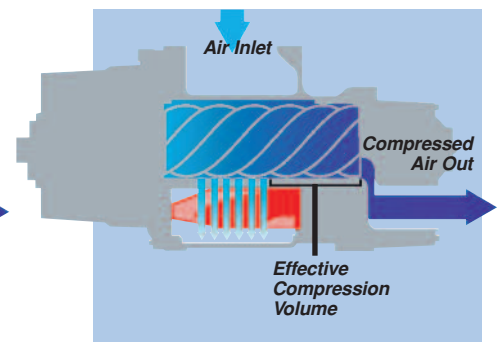

PART LOAD PERFORMANCE ASSESSMENT

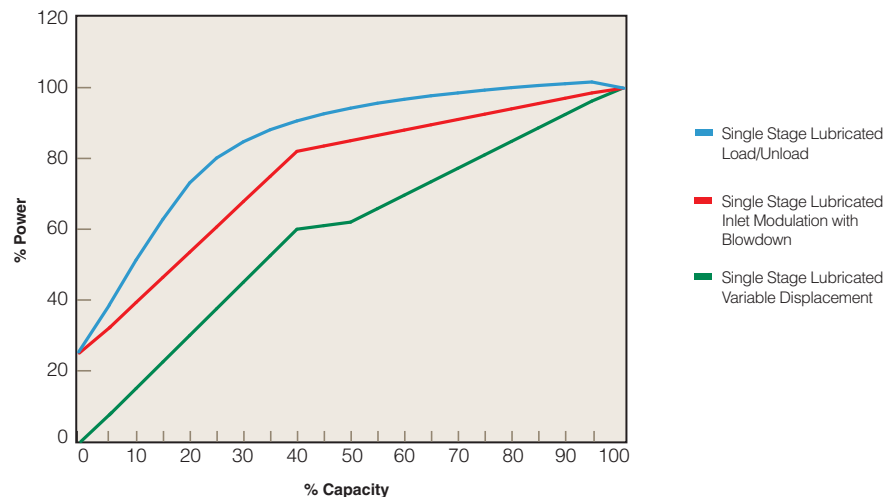

The *Senergy*® Performance Air System

Clean, dry air is essential

Quality air treatment — the removal of condensate and particulate — is essential. When cooled, vapor in compressed air will condense. The removal of condensate and particulate is essential for quality air. First, the air must be dry. Vapor in compressed air will condense when cooled. Without removing the condensate, moisture in the air stream can damage your total compressed air system, product, or process. To protect your plant air system and air-using equipment, particulate must be removed by filtration. Sullair filters will provide this protection and improve the quality of your product or process. Proper filtration will also reduce your compressed air energy costs.



The Sullair Solution

The solution is the Performance Air System. The System includes a *Senergy*® compressor and a SRS Dryer. We've taken the guesswork out of putting your System together. All components of the System have been perfectly matched and sized to provide maximum performance, without paying for more than you need. Plus, the Performance Air System is simple to install and, because of its small

footprint, requires a minimum amount of floor space.

Sullair Air Quality Guarantee

Two Levels of Air Quality

Sullair recognizes that the requirements for air quality vary according to each compressed air application. For this reason, Sullair provides compressed air systems that achieve two distinct levels of air quality and a guarantee for each.

The Sullair System.

The Sullair System matches a Sullair compressor, a Sullair dryer and Sullair filters. Sullair assures that its System will meet specific performance levels throughout its operational life. We offer a one-year test/review period, backed by a purchase refund guarantee, to verify the performance of the Sullair System.

Select the System.

Select the air quality level to meet your plant air or process requirements. You can be assured that the quality of air from the Sullair System you specify will remain consistent for the life of the equipment. Sullair guarantees it... and that's as good as gold.

The Sullair Oil-Free Air Quality Guarantee.



The System consists of a Sullair compressor, Sullair dryer, and Sullair SCF and SCH or PF/PH filters. The compressed air from this system contains particulates no larger than .01 micron, including coalesced liquid water and lubricants.

Maximum remaining oil aerosol content is 0.01 parts per million by weight (ppm/w) @ 70°F, including oil vapor. The air from this Sullair System meets the most stringent ISO standard (ISO 8573.1, Class 1 for oil vapor and Class 2 for Particulate) for air quality.

The Sullair Critical Air Quality Guarantee.

The compressed air from this Sullair System exceeds the ISO standard (ISO 8573.1, Class 1 for oil vapor and Class 2 for Particulate). The System includes a Sullair compressor, Sullair dryer, and Sullair SCF, SCH, and SCC; or PF, PH, and PC filters. The odor-free compressed air from this system contains particulates no larger than 0.01 micron, including water and oil aerosol content of 0.01 parts per million by weight (ppm/w) @ 70°F. The remaining oil vapor content is less than 0.003 ppm/w.

These Systems are not intended to remove carbon monoxide, methyl isocyanate or other noxious, corrosive or toxic gases, vapors or fumes. The system does not provide breathing air.

A Concern for the Environment

Mindful of our natural resources that are used to create and supply electrical energy, Sullair is focused on conservation and committed to providing air compressors that will use this energy most efficiently.

Other environmental features of the **S-energy**® Series compressors include:

- Fully-sealed protection pan that will contain compressor fluid should any spill while servicing
- Coreless fluid filter of non-metallic design that can be either incinerated or crushed, virtually eliminating disposal concerns and expense
- Sullair's environmentally compatible fluid, Sullube™, is biodegradable
- We've reduced the cost and environmental impact of fluid disposal by offering 24KT™, a life long fluid that never needs changing
- Low fluid capacity reduces overall fluid costs and disposal issues
- Health and safety issues are addressed by utilizing a low noise fan design, reducing the sound level to as low as 67 dBA, for worker comfort. Additionally, Sullair mounts air-end, motor, and receiver on rubber isolators and insulates intake and exhaust louvers

The Industry's Most Comprehensive Warranties

Confidence in our high quality workmanship, materials, and components allows Sullair to offer these unprecedented warranties:

Emerald Five-Year Compressor Health Assurance



The Emerald Five-Year Warranty is available on nearly every Sullair Industrial compressor when one of Sullair's recommended compressor fluids is used. This unmatched warranty covers all major components: the air-end, motor, air/fluid receiver, fluid cooler, and aftercooler. *Uniquely, this warranty includes all parts and labor.*

Ultra Emerald Five-Year Compressor Warranty



With the Ultra Emerald Warranty, you get all the benefits of Sullair's Emerald Five-Year Compressor Health Assurance, with the added benefit of our Variable Speed Drive (VSD). Sullair compressors with VSD keep working at maximum efficiency for longer life and lower energy costs.

24KT™ and the Ten-Year Warranty

When you use the 24KT™ compressor fluid, the Sullair 24KT™ System carries an unprecedented ten-year warranty on the Sullair air-end. You receive the benefits of our five-year coverage on all other major components.

Sullair Oil-Free and Critical Air Guarantee



Sullair matches the ideal combination of compressor, dryer, and filters to remove atmospheric particulate, aerosols, and other pollutants to provide two levels of air quality—from general purpose to the most critical air applications.

Technical Specifications: 60 Hz

Constant Speed Drive Performance

Model	Motor HP	Full Load Capacity			
		acfm @ 100 psig	acfm @ 125 psig	acfm @ 150 psig	acfm @ 175 psig
1800	25	119	106	96	85
2200	30	140	127	111	104
3000	40	—	163	148	138
3000P	40	199	182	165	—
3700	50	250	222	196	179
4500	60	—	267	247	220
4500P	60	303	260	233	—
4500PS	60	310	276	—	—
5500	75	376	344	296	276
5500PS	75	387	349	—	—
7500	100	490	444	397	369
7500P	100	500	457	418	371
7500PS	100	500	457	418	371

Variable Speed Drive Performance

Model	Motor HP	Full Load Capacity			
		acfm @ 100 psig	acfm @ 125 psig	acfm @ 150 psig	acfm @ 175 psig
1800V	25	116	105	96	87
2200V	30	138	125	115	105
3000V	40	—	163	150	140
3000PV	40	200	180	163	148
3700V	50	249	225	202	183
4500V	60	—	260	238	222
4500PV	60	305	269	—	—
5500V	75	377	341	306	278
7500V	100	493	454	415	381
7500PV	100	500	457	420	394

Dimensions and Weights

Models	Length inches	Length with Integral Dryer inches	Width inches	Height inches	Weight lbs	Weight with Integral Dryer lbs	Discharge Connection	Moisture Drain Connection	dBa Rating*
1800	53.2	63	31.5	53.2	1420	1621	1-1/2" NPT	1/4" NPT	67
1800V	53.2	63	31.5	53.2	1461	1662	1-1/2" NPT	1/4" NPT	67
2200	53.2	63	31.5	53.2	1450	1651	1-1/2" NPT	1/4" NPT	67
2200V	53.2	63	31.5	53.2	1491	1692	1-1/2" NPT	1/4" NPT	67
3000	53.2	63	31.5	53.2	1615	1814	1-1/2" NPT	1/4" NPT	69
3000V	53.2	63	31.5	53.2	1654	1854	1-1/2" NPT	1/4" NPT	69
3000P	62.0	71.5	34.5	61.5	1990	2274	1-1/2" NPT	1/4" NPT	68
3000PV	62.0	71.5	34.5	61.5	2050	2334	1-1/2" NPT	1/4" NPT	68
3700	62.0	71.5	34.5	61.5	2040	2324	1-1/2" NPT	1/4" NPT	68
3700V	62.0	71.5	34.5	61.5	2100	2384	1-1/2" NPT	1/4" NPT	68
4500	62.0	71.5	34.5	61.5	2190	2474	1-1/2" NPT	1/4" NPT	69
4500V	62.0	71.5	34.5	61.5	2300	2584	1-1/2" NPT	1/4" NPT	69
4500P	78.7	91.9	43.3	68.9	2815	3188	2" NPT	1/4" NPT	72
4500PV	78.7	91.9	43.3	68.9	2952	3325	2" NPT	1/4" NPT	72
4500PS	78.7	91.9	43.3	68.9	2957	3330	2" NPT	1/4" NPT	70
5500	78.7	91.9	43.3	68.9	2886	3259	2" NPT	1/4" NPT	72
5500V	78.7	91.9	43.3	68.9	2963	3336	2" NPT	1/4" NPT	72
5500PS	78.7	91.9	43.3	68.9	3028	3401	2" NPT	1/4" NPT	70
7500	78.7	91.9	43.3	68.9	3213	3586	2" NPT	1/4" NPT	73
7500V	78.7	91.9	43.3	68.9	3405	3778	2" NPT	1/4" NPT	73
7500P	78.7	91.9	43.3	68.9	3280	3653	2" NPT	1/4" NPT	71
7500PV	78.7	91.9	43.3	68.9	3472	3845	2" NPT	1/4" NPT	71
7500PS	78.7	91.9	43.3	68.9	3355	3728	2" NPT	1/4" NPT	71

* at 1 Meter

** Capacity per CAGI / PNEUROP PN2CPTC2 (Annex C to ISO 1217)
Data subject to change without notice.



Global Support. Local Solutions.

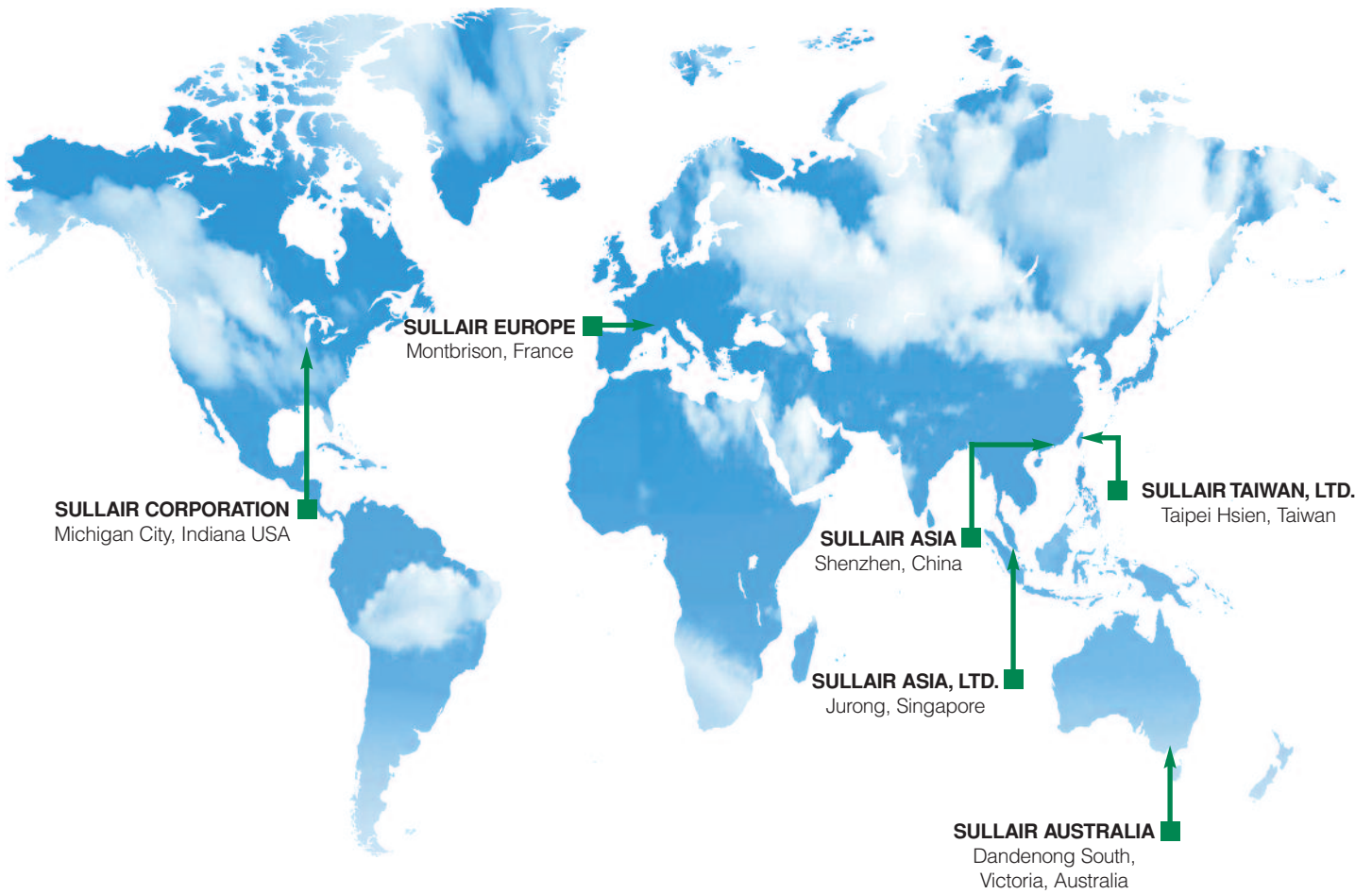

Sullair offers air system solutions to help compressed air users reduce their energy costs and improve their productivity by analyzing, managing and controlling total compressed air systems. Information on the compressed air system tailored to your specific needs can be obtained by contacting your local Sullair Distributor. To acquire local distributor contact information visit us online at www.sullair.com or call 219-879-5451.



Sullair Corporation
3700 East Michigan Boulevard, Michigan City, IN 46360
Telephone: 219-879-5451
www.sullair.com

Sullair Corporation, a Business Unit of Hamilton Sundstrand,
a United Technologies Company.
© Copyright 2010 Sullair Corporation. All rights reserved.
The color green is a registered trademark of Sullair Corporation.
Specifications subject to change without notice.
LS14E 1001R10



The paper used in printing this literature was manufactured using recycled fiber, either pre-consumer or post-consumer waste, therefore less harmful to the environment because less virgin fiber is used, thereby reducing tree harvesting, water usage, energy consumption, emission of greenhouse gases and pollution.

